

M12 male 0° / M12 female 90° A-cod. LED

PUR 3x0.34 ye UL/CSA+robot+drag ch. 2m

Male straight – female 90°

M12 – M12, 3-pole

2× LED (PNP), (NPN) on request

Art-No. 7005 - M12 Lite - (plastic hexagonal screw) on request

Plastic housings with good resistance against chemicals and oils.

The resistance to aggressive media should be individually tested for your application. Further details on request.

Further cable lengths on request.

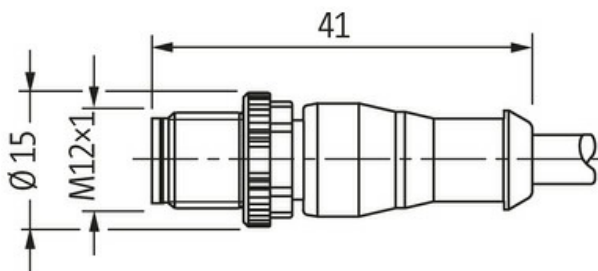
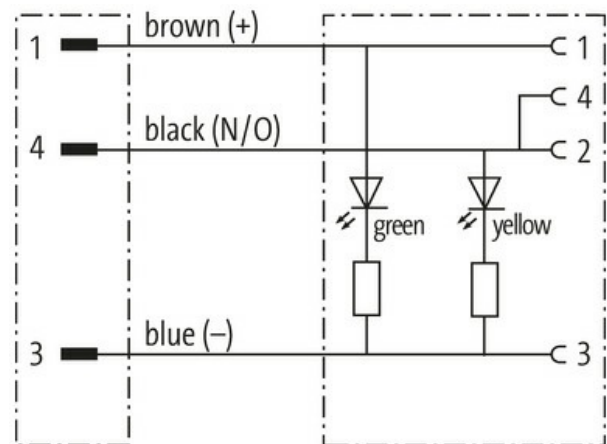
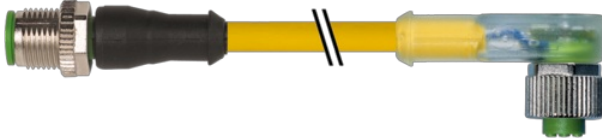
[Link to Product](#)**Illustration**

Male

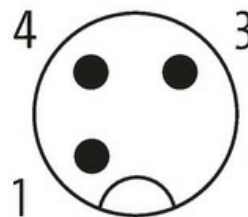

Female

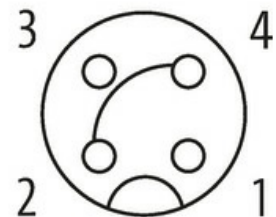

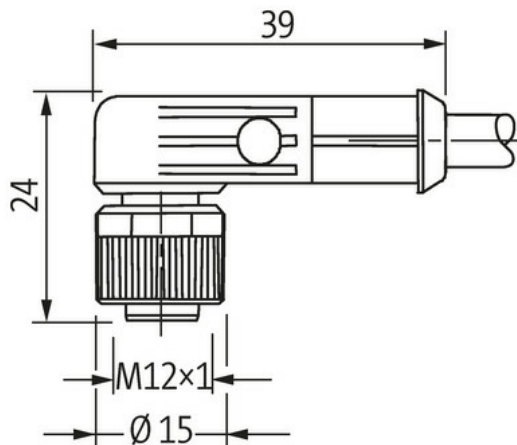

Product may differ from Image

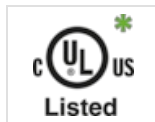

* only for products with UL/CSA approved cable

Form

Form 40381

Technical Data

| | |
|--|--|
| Operating voltage | 24 V DC $\pm 25\%$ |
| Operating voltage (only UL listed) | max. 30 V DC |
| Rated surge voltage | 0.8 kV |
| Operating current per contact | max. 4 A |
| Material group | IEC 60664-1, category I |
| Coding | A-coded |
| Locking of ports | Screw thread (M12x1 mm) recommended torque 0.6 Nm, self-securing |
| Compression gland | M12 (SW13) |
| Protection | IP65, IP66K, IP67 inserted and tightened (EN 60529) |
| Material | PUR |
| Locking material | Zinc die casting, matte nickel plated |
| suitable for corrugated tube (internal \varnothing) | 10 mm |

General data

| | |
|-------------------|--|
| Standards | DIN EN 61076-2-101 (M12) |
| Pollution Degree | 3 |
| Temperature range | -25...+85 °C, depending on cable quality |

Cables

| | |
|----------------------------------|---|
| No./diameter of wires | 3x 0.34 mm ² |
| Wire isolation | PP (br, bl, bk) |
| C-track properties | 10 Mio. |
| Outer \varnothing | 4.3 mm $\pm 5\%$ |
| Cable identification | 053 |
| Cable Type | 5 (PUR schweißfunkenbeständig) |
| Approval (cable) | cURus (AWM-Style 20549/10493); CE conform |
| Cable weight [g/m] | 29,7 g |
| Material (wire) | Cu wire, bare |
| Resistor (core) | max. 60 Ω /km (20 °C) |
| Single wire \varnothing (core) | 0.1 mm |
| Construction (core) | 42x 0.1 mm (multi-strand wire class 6) |

The information in this brochure has been compiled with the utmost care.

Liability for the correctness completeness and topicality of the information is restricted to gross negligence. Version: 03/22

| | |
|------------------------------------|---|
| Diameter (core) | 3× 0.34 mm ² |
| AWG | similar to AWG 22 |
| Material (wire isolation) | PP |
| Material property (wire isolation) | CFC-, halogen-, cadmium-, silicone- and lead-free |
| Shore hardness (wire isolation) | 74 ±3 D |
| Wire-Ø incl. isolation | 1.25 mm ±5% |
| Color/numbering of wires | br, bk, bl |
| Stranding combination | 3 wires twisted |
| Shield | no |
| Material (jacket) | PUR |
| Material property (jacket) | CFC-, halogen-, cadmium-, silicone- and lead-free, matt, low-adhesion, machine easy to process, abrasion-resistant, hydrolysis-, microbial- and welding spark resistant |
| Shore hardness (jacket) | 58 ±3 D |
| Outer-Ø (jacket) | 4.3 mm ±5% |
| Color (jacket) | yellow |
| Jacket Color | yellow |
| chemical resistance | good resistance to oil, gasoline and chemicals (EN 60811-404) |
| thermal resistance | flame retardant UL, FT2, IEC 60332-1, IEC 60332-2-2, welding spark resistant |
| Nominal voltage | 300 V AC |
| Test voltage | 2500 V AC |
| Current load capacity | to DIN VDE 0298-4 |
| Temperature range (fixed) | -40...+80 °C |
| Temperature range (fixed) | -40...+80 °C, (+90 °C at max. 10 000 operating hours) |
| Temperature range (mobile) | -25...+80 °C |
| Temperature range (mobile) | -25...+80 °C, (+90 °C at max. 10 000 operating hours) |
| Bend radius (fixed) | 5× outer Ø |
| Bend radius (moving) | 10× outer Ø |
| Bend radius (moving) | 10× outer Ø |
| No. of bending cycles (C-track) | max. 10 Mio. (25 °C) |
| Travel speed (C-track) | max. 3.3 m/s |
| Acceleration (C-track) | max. 5 m/s ² |
| Torsion stress | ±360°/m |
| No. of torsion cycles | max. 1 Mio. (25 °C) |
| Torsion speed | 35 cycles/min |
| Material (jacket) | PUR (UL/CSA), welding spark |

Commercial data

| | |
|-----------------------|---------------|
| country of origin | DE |
| customs tariff number | 85444290 |
| EAN | 4048879167901 |
| eClass | 27279218 |
| Packaging unit | 1.000 |