



Main

Range of product	Harmony XALD
Product or component type	Empty control station
Device short name	XALD
Product destination	For XB5 Ø 22 mm control and signalling units
Number of cut-out	5 cut-outs
Colour of base of enclosure	Light grey RAL 7035
Colour of cover	Dark grey RAL 7016
Material	Polycarbonate
Cable entry	2 knock-outs for Pg 13 cable gland and ISO M20, clamping capacity: <= 12 mm 2 knock-outs for cable entry, clamping capacity: <= 14 mm
IP degree of protection	IP66 conforming to IEC 60529

Complementary

Assembly style	For customer assembly
Number of vertical rows	5
Product weight	0.322 kg
Resistance to high pressure washer	7000000 Pa at 55 °C, distance: 0.1 m
Mounting of block	Front mounting Rear mounting
Electrical composition code	SR1 SR2 MR1 MF1 PF1 MF2 PF2 SF1 SF2 PR1
Main group	5 cut-outs
Group of product	Standard grey

Environment

Protective treatment	TH
Ambient air temperature for storage	-40...70 °C
Ambient air temperature for operation	-25...70 °C
Class of protection against electric shock	Class II conforming to IEC 60536
NEMA degree of protection	NEMA 4X NEMA 13
IK degree of protection	IK03 conforming to EN 50102
Standards	EN/IEC 60947-1 EN/IEC 60947-5-1 EN/IEC 60947-5-4 EN/IEC 60947-5-5 JIS C 4520 UL 508 CSA C22.2 No 14

The information provided in this documentation contains general descriptions and/or technical characteristics of the performance of the products contained herein. This documentation is not intended as a substitute for and is not to be used for determining suitability or reliability of these products for specific user applications. It is the duty of any such user or integrator to perform the appropriate and complete risk analysis, evaluation and testing of the products with respect to the relevant specific application or use thereof. Neither Schneider Electric Industries SAS nor any of its affiliates or subsidiaries shall be responsible or liable for misuse of the information contained herein.

Not classified

Number of horizontal rows

1

Dimensions

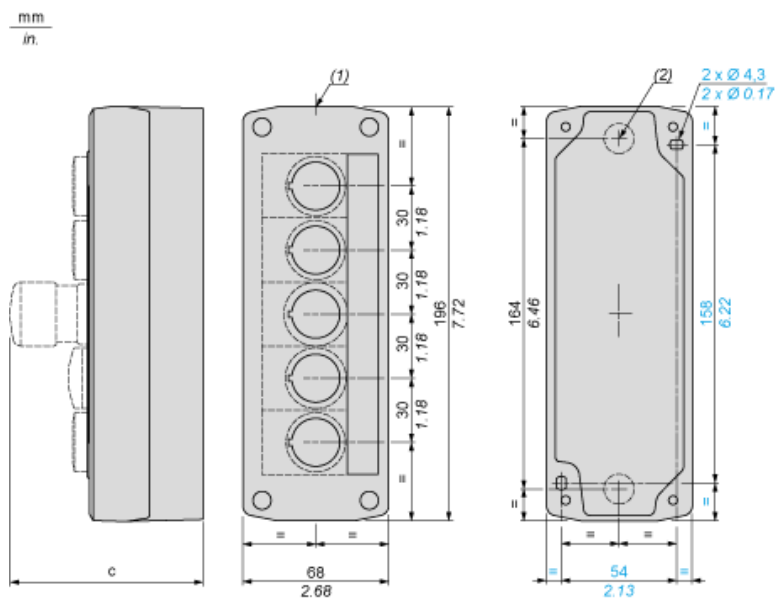

- (1) 2 knock-outs for Pg 13.5 cable gland, maximum capacity 12 mm/0.47 in.
 (2) Knock-out for cable entry, maximum capacity 14 mm/0.55 in.

Control station fitted with:	c in mm	c in in.
Flush pushbutton	62	2.44
Pilot light	64	2.52
Illuminated pushbutton	65.5	2.58
Projecting pushbutton	66	2.60
Selector switch	80	3.15
Mushroom head pushbutton	91.5	3.58
Latching mushroom head Emergency stop pushbutton with key	115	4.53
Key switch	105.5	4.15