



Main

Range of product	Zelio Logic
Product or component type	Modular smart relay

Complementary

Local display	With
Number of control scheme lines	120 with ladder programming <= 200 with FBD programming
Cycle time	6...90 ms
Backup time	10 years at 25 °C
Clock drift	6 s/month at 25 °C 12 min/year at 0...55 °C
Checks	Program memory on each power up
[Us] rated supply voltage	24 V
Supply voltage limits	19.2...30 V
Supply current	100 mA (without extension) 100 mA (with extensions)
Power dissipation in W	8 W with extensions 3 W without extension
Reverse polarity protection	With
Discrete input number	6 conforming to EN/IEC 61131-2 type 1
Discrete input type	Resistive
Discrete input voltage	24 V DC
Discrete input current	4 mA
Counting frequency	1 kHz for discrete input
Voltage state 1 guaranteed	>= 15 V for IB...IG used as discrete input circuit >= 15 V for I1...IA and IH...IR discrete input circuit
Voltage state 0 guaranteed	<= 5 V <= 5 V for IB...IG used as discrete input circuit <= 5 V for I1...IA and IH...IR discrete input circuit
Current state 1 guaranteed	>= 2.2 mA for I1...IA and IH...IR discrete input circuit >= 1.2 mA for IB...IG used as discrete input circuit
Current state 0 guaranteed	< 0.75 mA for I1...IA and IH...IR discrete input circuit < 0.5 mA for IB...IG used as discrete input circuit
Input compatibility	3-wire proximity sensors PNP (discrete input)
Analogue input number	4
Analogue input type	Common mode
Analogue input range	0...10 V 0...24 V
Maximum permissible voltage	30 V (analogue input circuit)
Analogue input resolution	8 bits
LSB value	39 mV (analogue input circuit)
Conversion time	Smart relay cycle time for analogue input circuit

Conversion error	+/- 6.2 % at 55 °C for analogue input circuit +/- 5 % at 25 °C for analogue input circuit
Repeat accuracy	+/- 2 % at 55 °C for analogue input circuit
Operating distance	10 m between stations, with screened cable (sensor not isolated) for analogue input circuit
Input impedance	7.4 kOhm (I1...IA and IH...IR discrete input circuit) 12 kOhm (IB...IG used as discrete input circuit) 12 kOhm (IB...IG used as analogue input circuit)
Number of outputs	4 relay output(s)
Output voltage limits	5...30 V DC (relay output) 24...250 V AC (relay output)
Contacts type and composition	NO for relay output
Output thermal current	8 A for all 4 outputs (relay output)
Electrical durability	500000 cycles DC-13 at 24 V, 0.6 A for relay output conforming to EN/IEC 60947-5-1 500000 cycles DC-12 at 24 V, 1.5 A for relay output conforming to EN/IEC 60947-5-1 500000 cycles AC-15 at 230 V, 0.9 A for relay output conforming to EN/IEC 60947-5-1 500000 cycles AC-12 at 230 V, 1.5 A for relay output conforming to EN/IEC 60947-5-1
Switching capacity in mA	>= 10 mA at 12 V (relay output)
Operating rate in Hz	10 Hz (no load) for relay output 0.1 Hz (at le) for relay output
Mechanical durability	10000000 cycles (relay output)
[Uimp] rated impulse withstand voltage	4 kV conforming to EN/IEC 60947-1 and EN/IEC 60664-1
Clock	With
Response time	5 ms (from state 1 to state 0) for relay output 10 ms (from state 0 to state 1) for relay output
Connections - terminals	Screw terminals, clamping capacity: 2 x 0.25...2 x 0.75 mm ² AWG 24...AWG 18 flexible with cable end Screw terminals, clamping capacity: 2 x 0.2...2 x 1.5 mm ² AWG 24...AWG 16 solid Screw terminals, clamping capacity: 1 x 0.25...1 x 2.5 mm ² AWG 24...AWG 14 flexible with cable end Screw terminals, clamping capacity: 1 x 0.2...1 x 2.5 mm ² AWG 25...AWG 14 solid Screw terminals, clamping capacity: 1 x 0.2...1 x 2.5 mm ² AWG 25...AWG 14 semi-solid
Tightening torque	0.5 N.m
Overvoltage category	III conforming to EN/IEC 60664-1
Product weight	0.25 kg

Environment

Immunity to microbreaks	<= 1 ms
Product certifications	CSA C-Tick GL GOST UL
Standards	EN/IEC 60068-2-27 Ea EN/IEC 60068-2-6 Fc EN/IEC 61000-4-11 EN/IEC 61000-4-12 EN/IEC 61000-4-2 level 3 EN/IEC 61000-4-3 EN/IEC 61000-4-4 level 3 EN/IEC 61000-4-5 EN/IEC 61000-4-6 level 3
IP degree of protection	IP40 (front panel) conforming to IEC 60529 IP20 (terminal block) conforming to IEC 60529
Environmental characteristic	Low voltage directive conforming to EN/IEC 61131-2 EMC directive conforming to EN/IEC 61131-2 zone B EMC directive conforming to EN/IEC 61000-6-4 EMC directive conforming to EN/IEC 61000-6-3 EMC directive conforming to EN/IEC 61000-6-2
Disturbance radiated/conducted	Class B conforming to EN 55022-11 group 1
Pollution degree	2 conforming to EN/IEC 61131-2

Ambient air temperature for operation	-20...55 °C conforming to IEC 60068-2-1 and IEC 60068-2-2 -20...40 °C in non-ventilated enclosure conforming to IEC 60068-2-1 and IEC 60068-2-2
Ambient air temperature for storage	-40...70 °C
Operating altitude	2000 m
Altitude transport	<= 3048 m
Relative humidity	95 % without condensation or dripping water

Compact and Modular Smart Relays

Mounting on 35 mm/1.38 in. DIN Rail

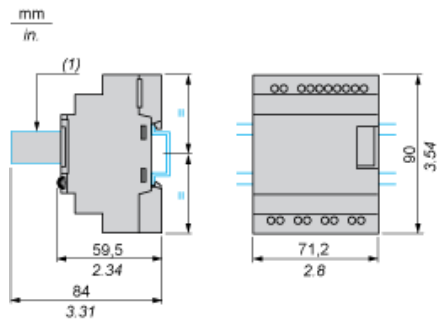

(1) With SR2USB01 or SR2BTC01

Screw Fixing (Retractable Lugs)



(1) With SR2USB01 or SR2BTC01

Position of Display



Compact and Modular Smart Relays

Connection of Smart Relays on DC Supply

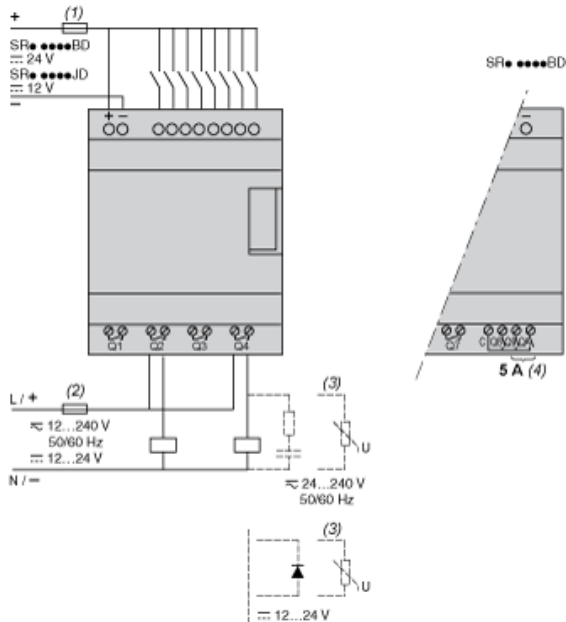

- (1) 1 A quick-blow fuse or circuit-breaker.
- (2) Fuse or circuit-breaker.
- (3) Inductive load.
- (4) Q9 and QA: 5 A (max. current in terminal C: 10 A).

Discrete Input Used for 3-Wire Sensors

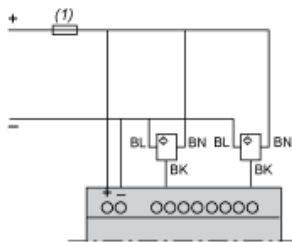

- (1) 1 A quick-blow fuse or circuit-breaker.

Connection of Smart Relays on DC Supply

Analog Inputs

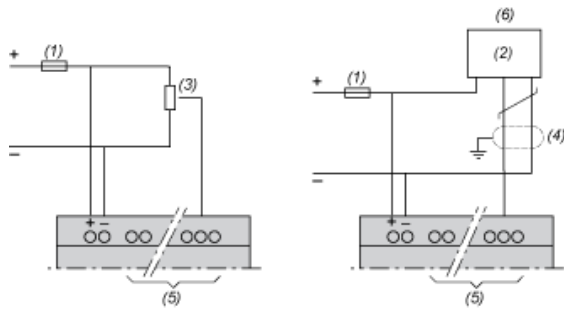

- (1) 1 A quick-blow fuse or circuit-breaker.
- (2) Ca: Analog sensor / Ta: Analog transmitter.
- (3) Recommended values: 2.2 kΩ / 0.5 W (10 kΩ max.)
- (4) Screened cables, maximum length 10 m / 32.80 feet.
- (5) Analog inputs according to Zelio Logic smart relay type (see table below)
- (6) 0-10 Vdc ANALOG

Smart Relays	Analog Inputs
SR2•12••D	IB...IE
SR2A201BD	IB and IC
SR2D201BD	IB and IC
SR2B20••D	IB...IG
SR2E201BD	IB...IG
SR3B10•BD	IB...IE
SR3B26••D	IB...IG

Connection of Smart Relays on DC Supply, with Discrete I/O Extension Modules

SR3B•••JD + SR3XT•••JD, SR3B•••BD + SR3XT•••BD

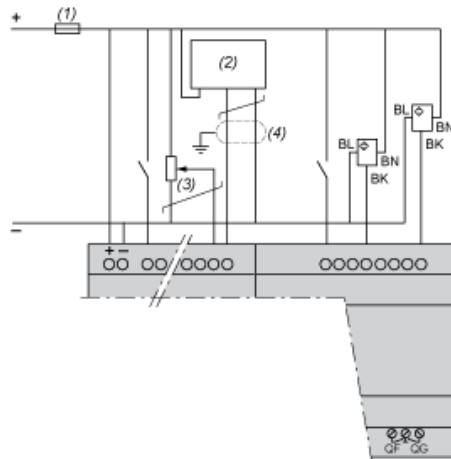

- (1) 1 A quick-blow fuse or circuit-breaker.
 - (2) Ca: Analog sensor / Ta: Analog transmitter.
 - (3) Recommended values: 2.2 kΩ / 0.5 W (10 kΩ max.)
 - (4) Screened cables, maximum length 10 m / 32.80 feet.
- QF and QG : 5 A for SR3XT141••

Compact and Modular Smart Relays

Electrical Durability of Relay Outputs

(in millions of operating cycles, conforming to IEC/EN 60947-5-1)

DC-12 (1)

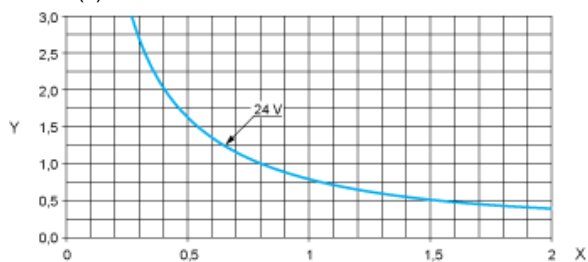

X: Current (A)

Y: Millions of operating cycles

(1) DC-12: control of resistive loads and of solid state loads isolated by opto-coupler, $L/R \leq 1$ ms.

DC-13 (1)

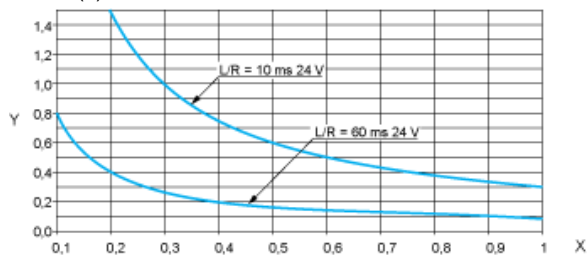

X: Current (A)

Y: Millions of operating cycles

(1) DC-13: switching electromagnets, $L/R \leq 2 \times (U_e \times I_e)$ in ms, U_e : rated operational voltage, I_e : rated operational current (with a protection diode on the load, DC-12 curves must be used with a coefficient of 0.9 applied to the number in millions of operating cycles).